

# SLP-500G LEG PRESS

**THERE IS A RISK ASSUMED BY INDIVIDUALS WHO USE THIS TYPE OF EQUIPMENT. TO MINIMIZE RISK, YOU MUST FOLLOW THESE RULES:**

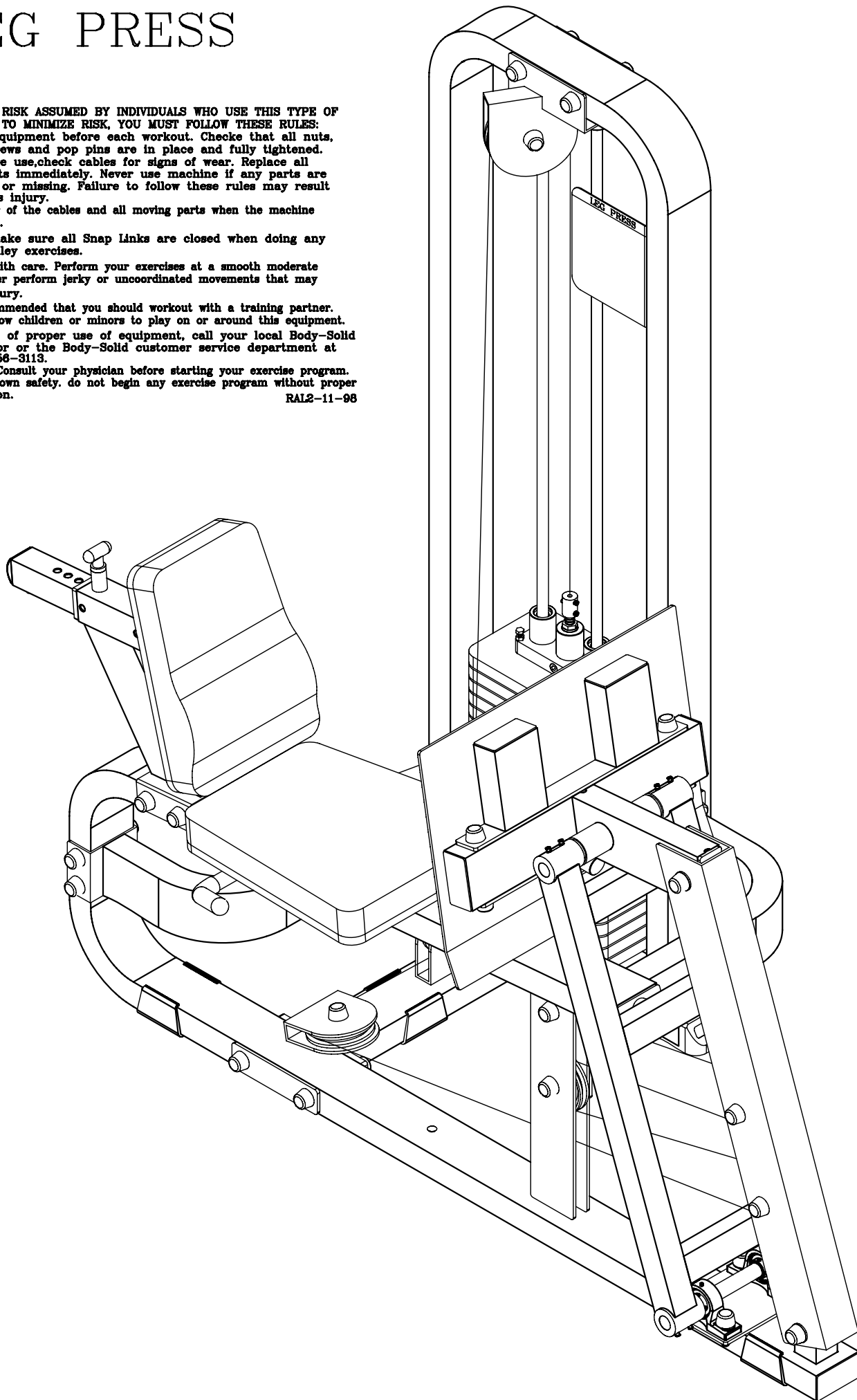









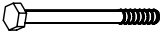

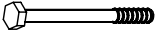
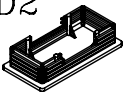
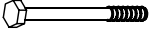
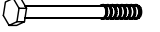

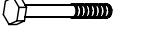

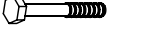

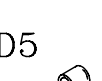























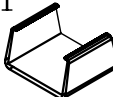

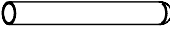
1. Inspect equipment before each workout. Check that all nuts, bolts, screws and pop pins are in place and fully tightened. Also, before use, check cables for signs of wear. Replace all worn parts immediately. Never use machine if any parts are damaged or missing. Failure to follow these rules may result in serious injury.
2. Keep clear of the cables and all moving parts when the machine is in use.
3. Always make sure all Snap Links are closed when doing any cable/pulley exercises.
4. Exercise with care. Perform your exercises at a smooth moderate pace; never perform jerky or uncoordinated movements that may cause injury.
5. It is recommended that you should workout with a training partner.
6. Do not allow children or minors to play on or around this equipment.
7. If unsure of proper use of equipment, call your local Body-Solid distributor or the Body-Solid customer service department at 1-800-556-3113.
8. **WARNING:** Consult your physician before starting your exercise program. For your own safety, do not begin any exercise program without proper instruction.

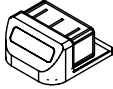
RA12-11-98

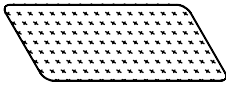

VERSION 200505

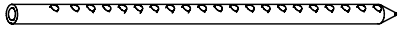
# SLP-500G HARDWARE ILLUSTRATION SHEET

		Qty.			Qty.	
	A1. 1/2"X5 3/4" HEX HEAD BOLT	[2PCS]	D1		D1. 1/2" BOLT CAP	[60PCS]
	A2. 1/2"X5 1/2" HEX HEAD BOLT	[6PCS]	D2		D2. 2"X4" END CAP (9211-014)	[5PCS]
	A3. 1/2"X5 1/4" HEX HEAD BOLT	[3PCS]	D3		D3. 2"X2"X1.8t END CAP (9211-087)	[2PCS]
	A4. 1/2"X5" HEX HEAD BOLT	[6PCS]	D5		D5. ø3/4" PULLEY SPACER (8110-017)	[4PCS]
	A5. 1/2"X3 3/4" HEX HEAD BOLT	[2PCS]	D6		D6. ø4" RUBBER DONUT (9310-017)	[2PCS]
	A6. 1/2"X3 1/2" HEX HEAD BOLT	[2PCS]	D7		D7. ø6" PULLEY (9213-009)	[1PCS]
	A7. 1/2"X2 1/2" HEX HEAD BOLT	[2PCS]	D8		D8. ø4 1/2" PULLEY (9213-010)	[5PCS]
	A8. 1/2"X2 1/4" HEX HEAD BOLT	[3PCS]	D9		D9. 60X50 NYLON BUSHING (9211-033)	[2PCS]
	A9. 1/2"X1 3/4" HEX HEAD BOLT	[4PCS]	D6		D10. ø3/4" SHAFT COLLAR (9211-046)	[2PCS]
	A10. 5/16"X3" HEX HEAD BOLT	[1PCS]	D7		D11. 2"X4" RUBBER DOUNT (9212-009)	[3PCS]
	A11. 5/16"X1 1/4" HEX HEAD BOLT	[6PCS]	D8		D12. ø1"X10" RUBBER GRIP (9310-029)	[2PCS]
	A12. 7/16"X1 1/2" ROUND BOLT	[1PCS]	D9		D13. 2"X4" FOOT END CAP (9211-028)	[2PCS]
	A13. 5/16"X3/8" SET SCREW	[3PCS]	D10		D14. 140X295 NO-SLIP TAPE (9630-004)	[2PCS]
	A14. 5/8" ROUND BOLT	[1PCS]	D11		D15. CHROME TOP PLATE (8400-002)	[1PCS]
	A15. 10LB BALL PIN	[1PCS]	D12		D16. WEIGHT SELECTOR BAR (8220-060)	[1PCS]
	A16. 5/8" EXTERNALLY THREADED SHAFT	[2PCS]	D13		D17. STEEL CABLE	[1PCS]
	B1. 1/2" NYLON LOCK NUT	[34PCS]	D14		D18. ø5/8" ROUND END CAP (9211-015)	[4PCS]
	B2. 5/8" LOCK NUT	[1PCS]	D10			
	C1. 1/2" ROUND END CAP WASHER	[60PCS]	D11			
	C2. 1/2" (I.D)WASHER	[25PCS]	D12			
	C3. 5/16" (I.D)WASHER	[7PCS]	D13			
	C4. 5/16" SPRING WASHER	[7PCS]	D14			
	C5. 1/2" SPRING WASHER	[4PCS]	D15			
	C6. 5/8" SPRING WASHER	[1PCS]	D16			
			D17			
			D18			

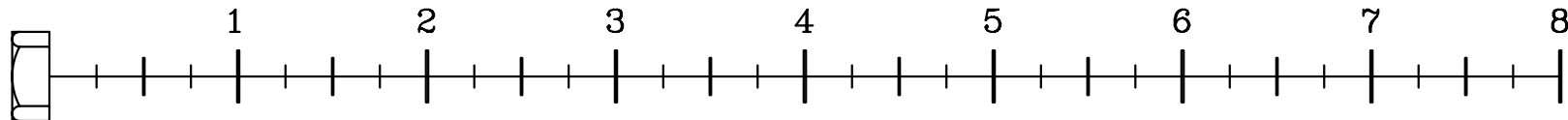

# SLP-500G

# PARTS ILLUSTRATION SHEET

A [1PCS] WEIGHT STACK FRAME

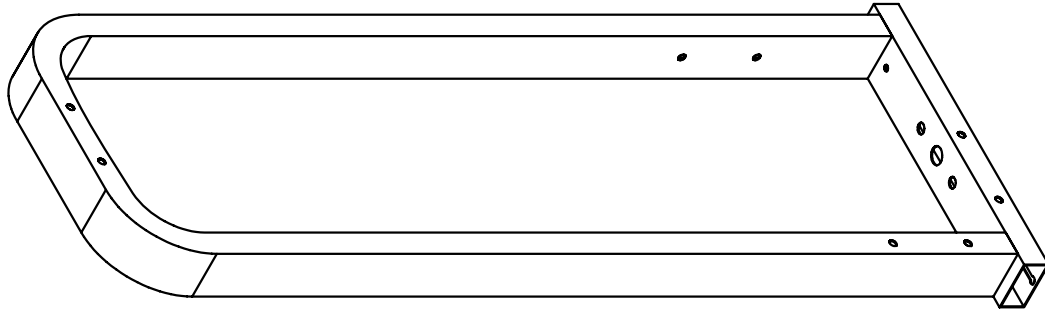

D [1PCS] MAIN BODY FRAME

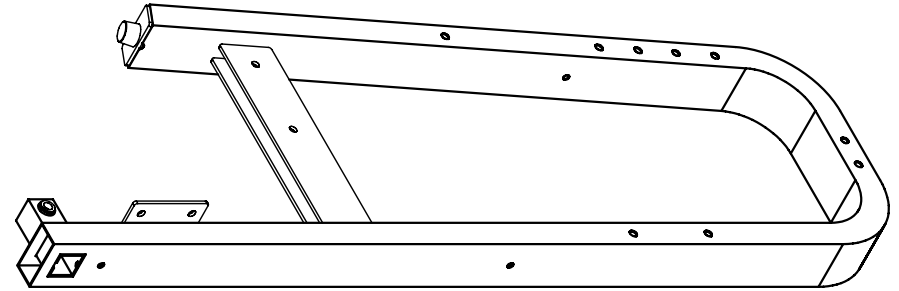

B [1PCS]  
BOTTOM PULLEY FRAME

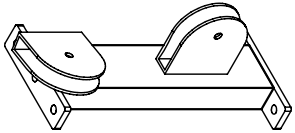

E [1PCS]  
LEG PRESS FRAME

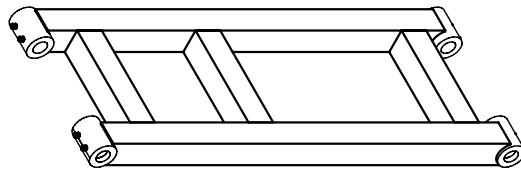

M [1PCS]  
RIGHT HANDLE

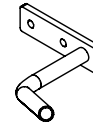

H [1PCS]  
FOOT PLATE

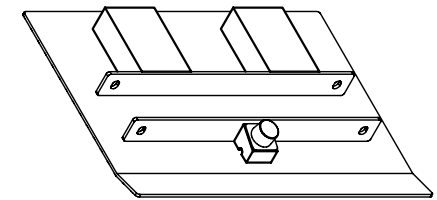

C [1PCS]  
FRONT SUPPORT FRAME

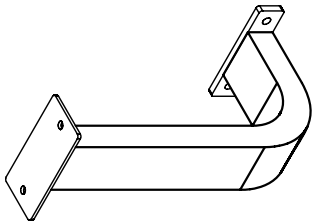

I [1PCS]  
ADJUSTABLE BACK SUPPORT

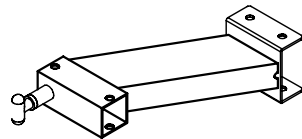

N [1PCS]  
LEFT HANDLE

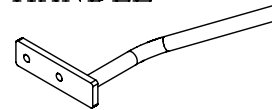

P [1PCS]  
TOP PULLEY FRAME

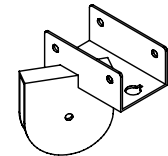

Q [1PCS]  
REAR SUPPORT FRAME

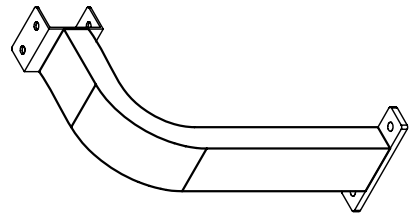

J [1PCS]  
BACK PAD FRAME

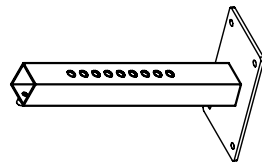

G [1PCS]  
FOOT PLATE FRAME

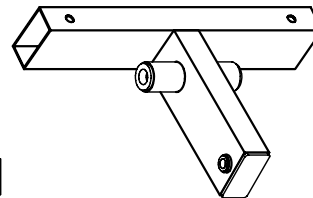

F [1PCS]  
FRONT PULLEY FRAME

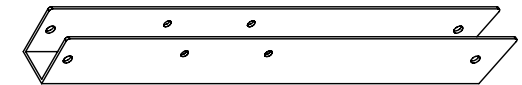

S [4PCS]  
2"X8" PLATE



T [2PCS]  
PAD BRACKET



O [2PCS]  
CHROME GUIDE ROD

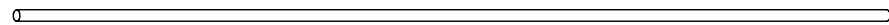

L [1PCS]  
SEAT PAD

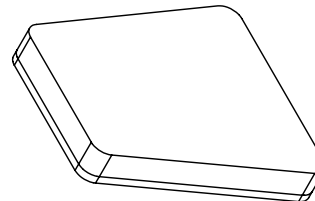

K [1PCS]  
BACK PAD

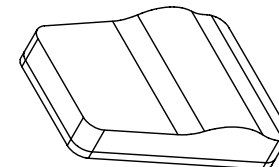



# SLP-500G LEG PRESS MACHINE

## ASSEMBLY STEPS

### STEP-1

**NOTE:** DO NOT TIGHTEN NUTS AND BOLTS SECURLY UNTIL YOU HAVE COMPLETED ALL ASSEMBLY STEPS.

- Attach **A** Weight Stack Frame and **D** Main Body Frame to **B** Bottom Pulley Frame.
- Attach **Q** Rear Support Frame to **A** Weight Stack Frame and **D** Main Body Frame.
- Attach **C** Front Support Frame to **A** Weight Stack Frame and **D** Main Body Frame.

**NOTE:** Attach Cable End to Top Bolt and **D8** Pulley to Bottom before tightening.

- Attach **M** and **N** Handles to **D** Main Body Frame.
- Attach **I** Adjustable Back Support to **D** Main Body Frame.
- Attach **T** Pad Brackets to **D** Main Body Frame.

### STEP-2

- Attach Pillow Blocks to **D** Main Body Frame.
- Attach **E** Leg Press Frame to Pillow Blocks.

**NOTE:** The Cross Beam of Part **E** Leg Press Frame the end is the bottom this end attaches to Pillow Blocks.

Pillow Blocks and other Cross Beam hits the Rubber Stopper on **D** Main Body Frame.

- Attach **F** Front Pulley Frame to **D** Main Body Frame.

**NOTE:** The Straigh 90° end goes to the bottom.

- Attach **G** Foot Plate Frame to **E** Leg Press Frame and **F** Front Pulley Frame.

**NOTE:** Part **G** Foot Plate Frame so the top of the Foot plate is slightly angled away from the user.

- Attach **H** Foot Plate to **G** Foot Plate Frame.

**CAUTION: DO NOT OVERTIGHTEN PAD BOLTS.  
OVERTIGHTENING WILL STRIP  
T-NUTS IN THE WOOD.**

### STEP-3

- Attach **K** Back Pad to **J** Back Pad Frame.
- Attach **L** Seat Pad to **D** Main Body Frame and **T** Pad Brackets.
- Slide **J** Back Pad Frame into **I** Adjustable Back Support.
- Attach **O** Chrome Guide Rod and **D6** Rubber Donuts to **A** Weight Stack Frame.
- Slide Weight Stack and **D15** Chrome Top Plate onto **O** Chrome Guide Rods.
- Attach **P** Top Pulley Frame to **A** Weight Stack and attach **D10** Shaft Collar.

### STEP-4

- Attach Pulleys and Cables as shown.
- Attach End Caps. Grips and No-Slip Tape.
- TIGHTEN ALL NUTS AND BOLTS SECURELY.
- Attach Bolt Caps.

### SAFETY RULES

1. Periodically check that all nuts,bolts and screws are fully tightened on your LEG PRESS MACHINE.
2. Exercise with care. Perform your exercises at a smooth moderate pace; never perform jerky or uncoordinated movements that may cause injury.
3. It is recommended that you should workout with a training partner.
4. **Warning:** CONSULT YOUR PHYSICIAN BEFORE STARTING YOUR EXERCISE PROGRAM. IT IS ADVISABLE TO HAVE A PHYSICAL EXAMINATION BEFORE YOU ENTER ANY EXERCISE PROGRAM. FOR YOUR OWN SAFETY, DO NOT BEGIN ANY EXERCISE WITHOUT PROPER INSTRUCTION.

# SLP-500G LEG PRESS

